

# FORTIS Rechteckige Duschkabine 1100x800 mm, R Variante



**Bestellcode:** FL1011RFL3580

## Grundinformation

**Marke:** Polysan

**Serie:** FORTIS

## Größe

**Breite:** 1100 mm

**Höhe:** 2000 mm

**Tiefe:** 800 mm

## Eigenschaften

**Farbenprofil:** Chrom - Poliertem Aluminium

**Form:** Rechteckige Duschtrennungen

**Öffnungsarten:** Öffnungstür einflügelig

**Richtung der Öffnung:** Rechts

**Eingangsbreite:** 565 mm

**Glasfarbe:** Klarglas

**Glasbehandlung:** Antidrop

**Glasdicke:** 8 mm

**Eigenschaften:** Rahmenloses Design

**Gewicht / Stück:** 84.0 kg

**Verpackung:** 2 Stück

**Garantie:** 2 Jahre



Technisches Arbeitsblatt



**FORTIS** Rechteckige Duschkabine 1100x800 mm, R  
Variante



Dveře	A (mm)	B (mm)	C (mm)
FL1080	785-801	≈ 200	779-795
FL1090	885-901	≈ 300	879-895
FL1010	985-1001	≈ 400	979-995
FL1011	1085-1101	≈ 500	1079-1095
FL1012	1185-1201	≈ 600	1179-1195
FL1113	1285-1301	≈ 700	1279-1295
FL1114	1385-1401	≈ 800	1379-1395
FL1115	1485-1501	≈ 900	1479-1495

Boční stěna	E	D
FL3580	785-801	779-795
FL3590	885-901	879-895
FL3510	985-1001	979-995

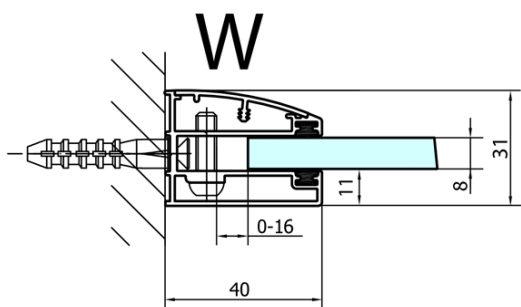

**FORTIS Rechteckige Duschkabine 1100x800 mm, R**  
**Variante**



Stavební připravenost pro montáž na dlažbu  
 kóty  $x, y$  = Rozměr k vnitřní straně skla

Construction readiness for floor mounting  
 dimensions  $x, y$  = Dimension to the inside of the glass

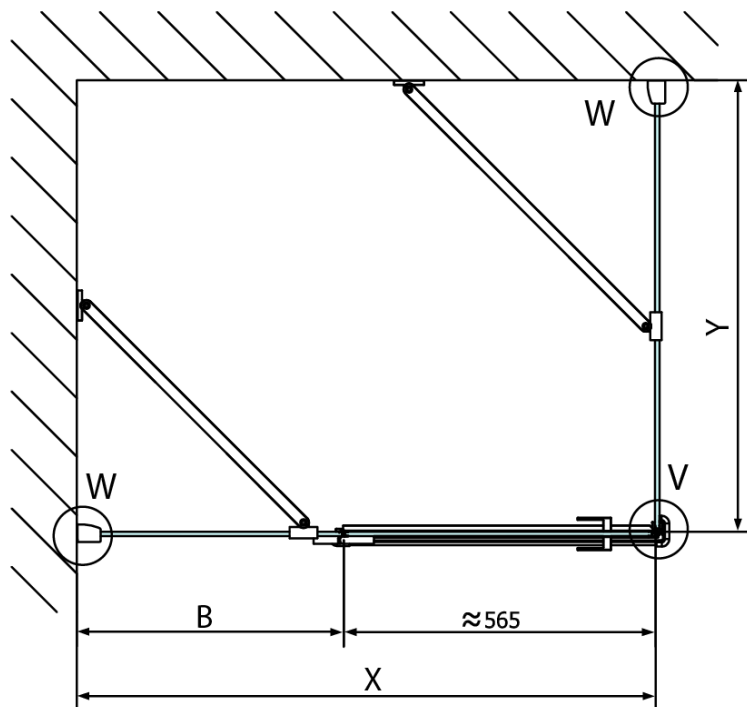

Dveře	X (mm)	B (mm)
FL1080	768	$\approx 200$
FL1090	868	$\approx 300$
FL1010	968	$\approx 400$
FL1011	1068	$\approx 500$
FL1012	1168	$\approx 600$
FL1113	1268	$\approx 700$
FL1114	1368	$\approx 800$
FL1115	1468	$\approx 900$

Boční stěna	Y
FL3580	768
FL3590	868
FL3510	968
FL3511	1068
FL3512	1168

