

FORTIS Rechteckige Duschkabine 1100x800 mm, R Variante



Bestellcode: FL1011RFL3580

Grundinformation

Marke: Polysan

Serie: FORTIS

Größe

Breite: 1100 mm

Höhe: 2000 mm

Tiefe: 800 mm

Eigenschaften

Farbenprofil: Chrom - Poliertem Aluminium

Form: Rechteckige Duschtrennungen

Öffnungsarten: Öffnungstür einflügelig

Richtung der Öffnung: Rechts

Eingangsbreite: 565 mm

Glasfarbe: Klarglas

Glasbehandlung: Antidrop

Glasdicke: 8 mm

Eigenschaften: Rahmenloses Design

Gewicht / Stück: 84.0 kg

Verpackung: 2 Stück

Garantie: 2 Jahre



Technisches Arbeitsblatt



FORTIS Rechteckige Duschkabine 1100x800 mm, R
Variante



Dveře	A (mm)	B (mm)	C (mm)
FL1080	785-801	≈ 200	779-795
FL1090	885-901	≈ 300	879-895
FL1010	985-1001	≈ 400	979-995
FL1011	1085-1101	≈ 500	1079-1095
FL1012	1185-1201	≈ 600	1179-1195
FL1113	1285-1301	≈ 700	1279-1295
FL1114	1385-1401	≈ 800	1379-1395
FL1115	1485-1501	≈ 900	1479-1495

Boční stěna	E	D
FL3580	785-801	779-795
FL3590	885-901	879-895
FL3510	985-1001	979-995

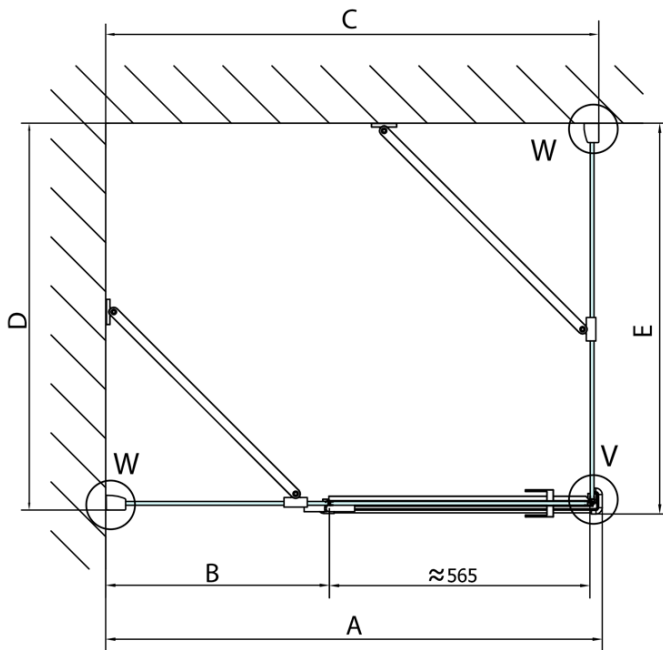

FORTIS Rechteckige Duschkabine 1100x800 mm, R
Variante



Stavební připravenost pro montáž na dlažbu
 kóty x, y = Rozměr k vnitřní straně skla

Construction readiness for floor mounting
 dimensions x, y = Dimension to the inside of the glass



Dveře	X (mm)	B (mm)
FL1080	768	≈ 200
FL1090	868	≈ 300
FL1010	968	≈ 400
FL1011	1068	≈ 500
FL1012	1168	≈ 600
FL1113	1268	≈ 700
FL1114	1368	≈ 800
FL1115	1468	≈ 900

Boční stěna	Y
FL3580	768
FL3590	868
FL3510	968
FL3511	1068
FL3512	1168

