

Bestellcode: GS120G

Grundinformation

Marke: Gelco

Größe

Breite: 325 mm

Tiefe: 325 mm

Eigenschaften

Farbe: Grau

Art: Duschsitz / Badstuhl

Installation: Bohren

Belastbarkeit: 120 kg

Gewicht / Stück: 3.5 kg

Verpackung: 1 Stück

Garantie: 2 Jahre



Technisches Arbeitsblatt

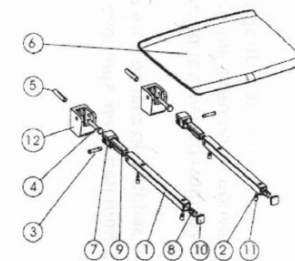
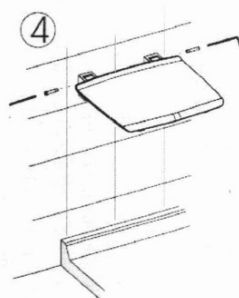
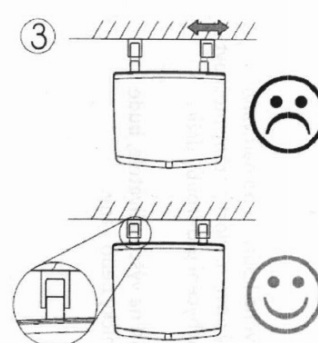
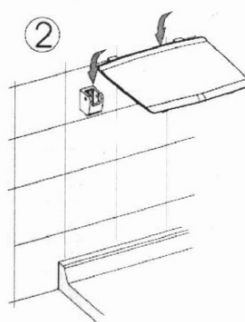
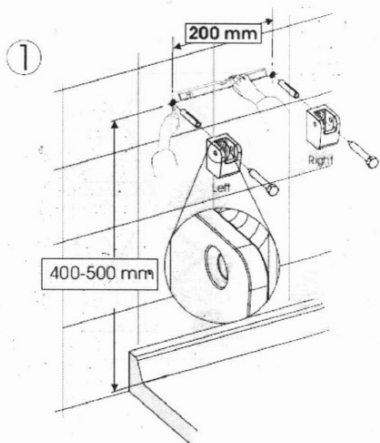
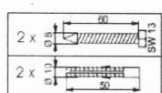
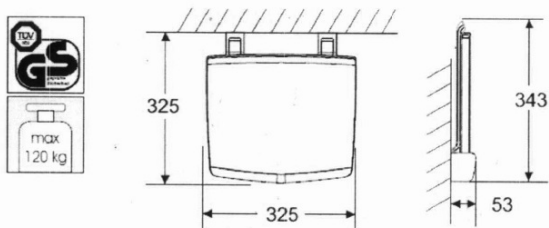

| Pos | No. articolo | quant. | Materiale |
|-----|--------------|--------|------------|
| 1 | 00428Z00F | 2 | INCK |
| 2 | 00438F00F | 4 | INCK A2 |
| 3 | 00808Z00F | 2 | INCK |
| 4 | 00818F00F | 4 | PNL |
| 5 | 0961A000G | 1 | AMg307 F27 |
| 6 | 1293K**F | 1 | ASS |
| 7 | 1292K**F | 2 | PNL |
| 8 | 1293K**F | 2 | PNL |
| 9 | 1294K**F | 2 | PNL |
| 10 | 1296K**F | 2 | ASS |
| 11 | 1297K**F | 4 | ASS |
| 12 | 1970K**G | 2 | AMg305 |