

**Bestellcode:** DL3415

**Grundinformation**

**Marke:** Polysan  
**Serie:** LUCIS LINE

**Größe**

**Höhe:** 2000 mm  
**Tiefe:** 900 mm

**Eigenschaften**

**Farbenprofil:** Chrom - Poliertem Aluminium  
**Form:** Feste Wand zur Duschtür  
**Glasfarbe:** Klarglas  
**Glasbehandlung:** Antidrop  
**Glasdicke:** 8 mm  
**Gewicht / Stück:** 37.0 kg  
**Verpackung:** 1 Stück  
**Garantie:** 2 Jahre



Technisches Arbeitsblatt

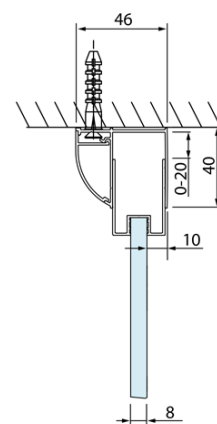
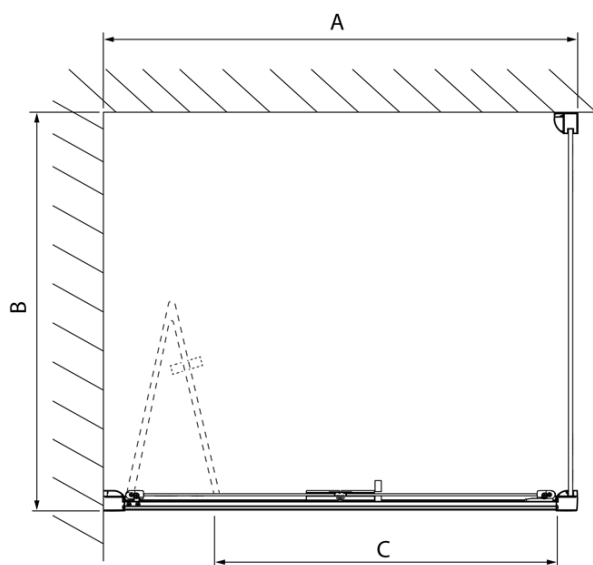
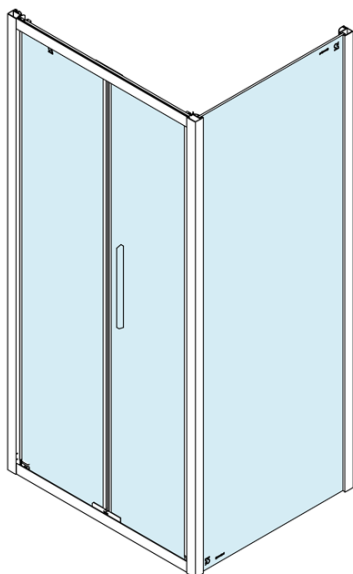

Model	A	C
DL2715	770-810	575
DL2815	870-910	675

Model	B
DL3215	670-690
DL3315	770-790
DL3415	870-890
DL3515	970-990

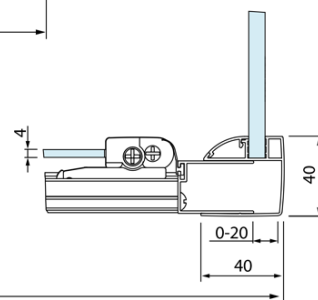
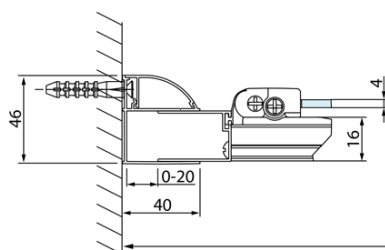

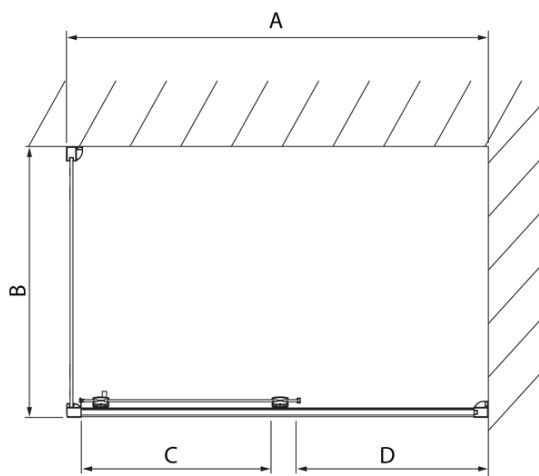
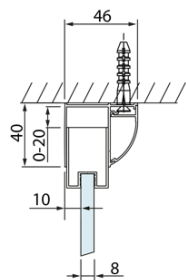
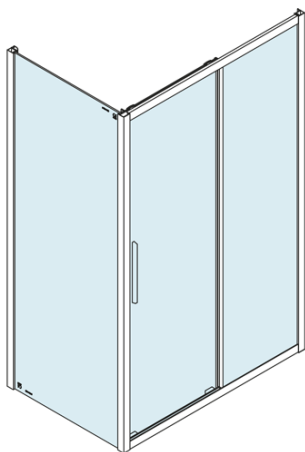

Model	A	C	D
DL1015	970-1010	375	~437
DL1115	1070-1110	425	~487
DL1215	1170-1210	475	~537
DL1315	1270-1310	525	~587
DL1415	1370-1410	575	~637

Model	B
DL3215	670-690
DL3315	770-790
DL3415	870-890
DL3515	970-990

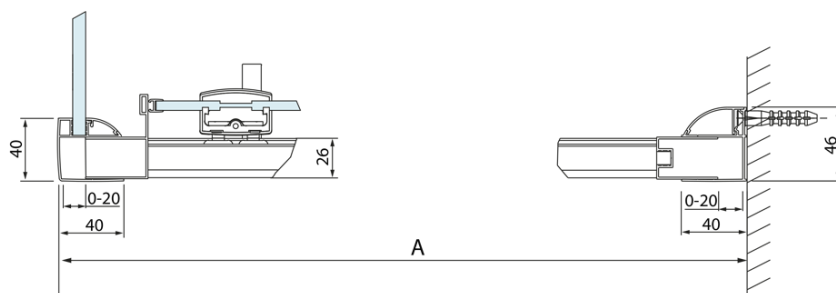

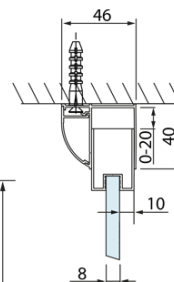
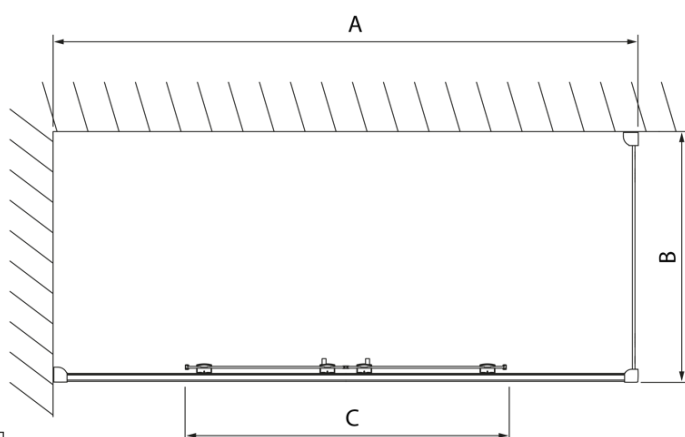
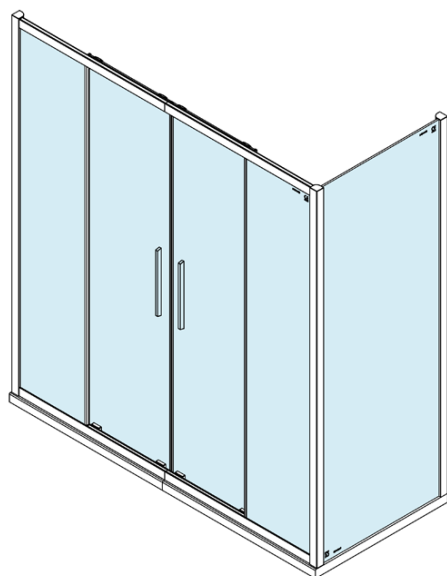

Model	A	C
DL4215	1470-1510	560
DL4315	1570-1610	610

Model	B
DL3215	670-690
DL3315	770-790
DL3415	870-890
DL3515	970-990

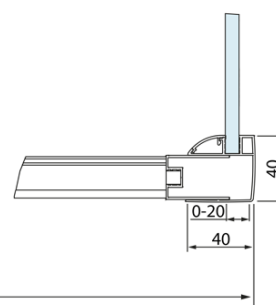
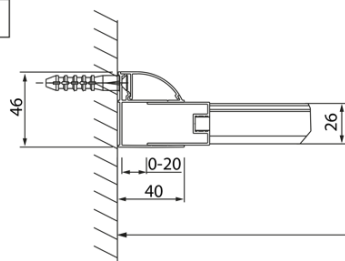

A