

Bestellcode: DL3215

Grundinformation

Marke: Polysan
Serie: LUCIS LINE

Größe

Höhe: 2000 mm
Tiefe: 700 mm

Eigenschaften

Farbenprofil: Chrom - Poliertem Aluminium
Form: Feste Wand zur Duschtür
Glasfarbe: Klarglas
Glasbehandlung: Antidrop
Glasdicke: 8 mm
Gewicht / Stück: 25.99 kg
Verpackung: 1 Stück
Garantie: 2 Jahre



Technisches Arbeitsblatt

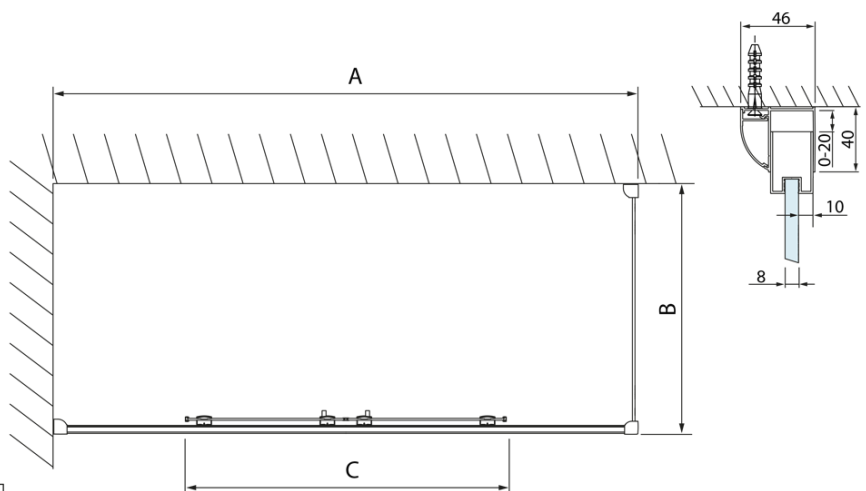
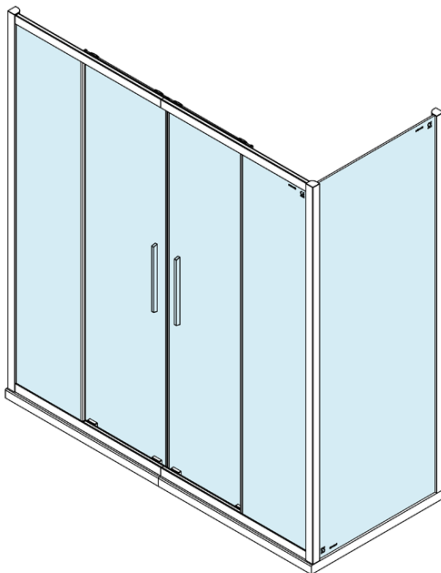

Model	A	C
DL4215	1470-1510	560
DL4315	1570-1610	610

Model	B
DL3215	670-690
DL3315	770-790
DL3415	870-890
DL3515	970-990

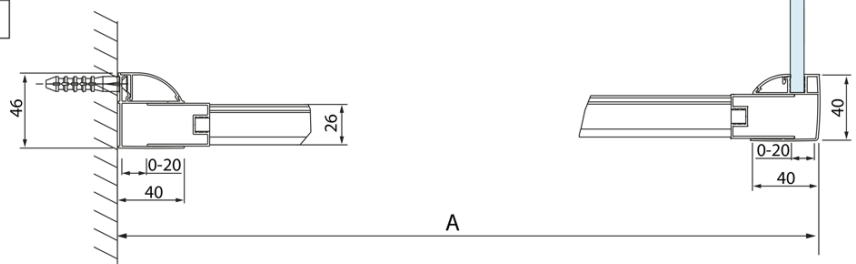

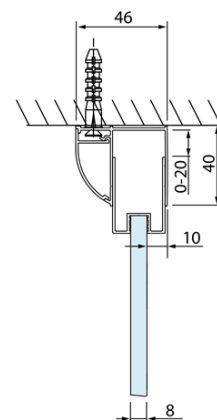
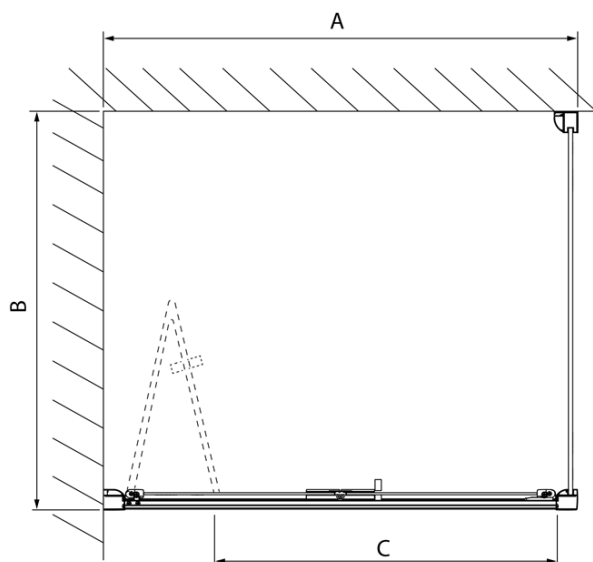
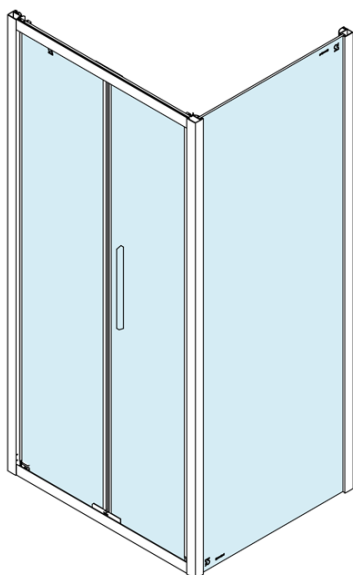

Model	A	C
DL2715	770-810	575
DL2815	870-910	675

Model	B
DL3215	670-690
DL3315	770-790
DL3415	870-890
DL3515	970-990

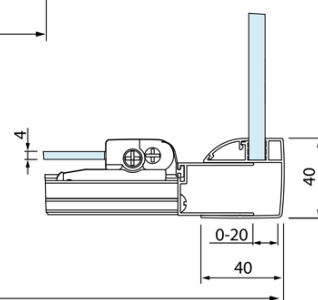
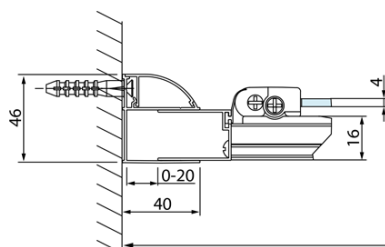

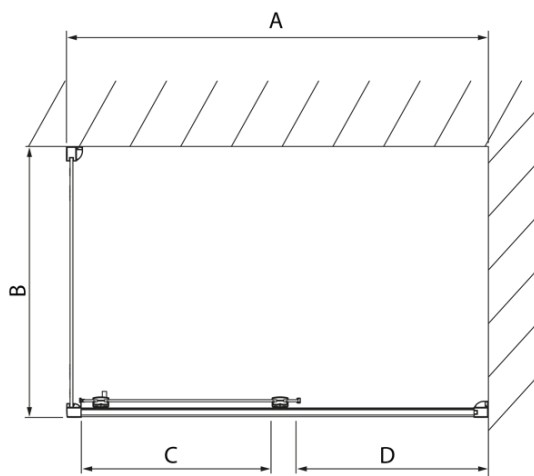
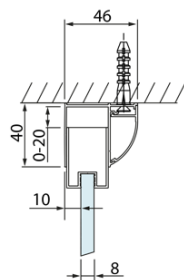
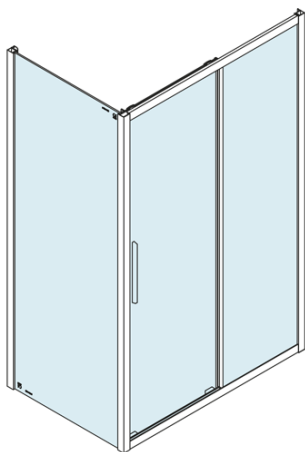

Model	A	C	D
DL1015	970-1010	375	~437
DL1115	1070-1110	425	~487
DL1215	1170-1210	475	~537
DL1315	1270-1310	525	~587
DL1415	1370-1410	575	~637

Model	B
DL3215	670-690
DL3315	770-790
DL3415	870-890
DL3515	970-990

