

Objednací kód: FL1113R

Základní informace

Značka: Polysan

Série: FORTIS

Rozměry

Šířka: 1300 mm

Výška: 2000 mm

Parametry

Barva profilu: Chrom - Leštěný hliník

Tvar: Dveře do kombinace

Typ otevírání: Otevírací jednokřídle

Typ výplně: Čiré sklo

Úprava skla: Antidrop

Tloušťka skla: 8 mm

Hmotnost / ks: 53.0 kg

Balení: 1 ks

Záruka: 2 roky



Náhradní díly

Těsnění na dveře (okapnička) na 8mm sklo, 1000mm (Objednací kód: 309D-08)

Akrylové těsnění mezi skla 8mm, praporek (Objednací kód: NDFL0503)

Technický list



FL10xxL
FL11xxL



FL10xxR
FL11xxR

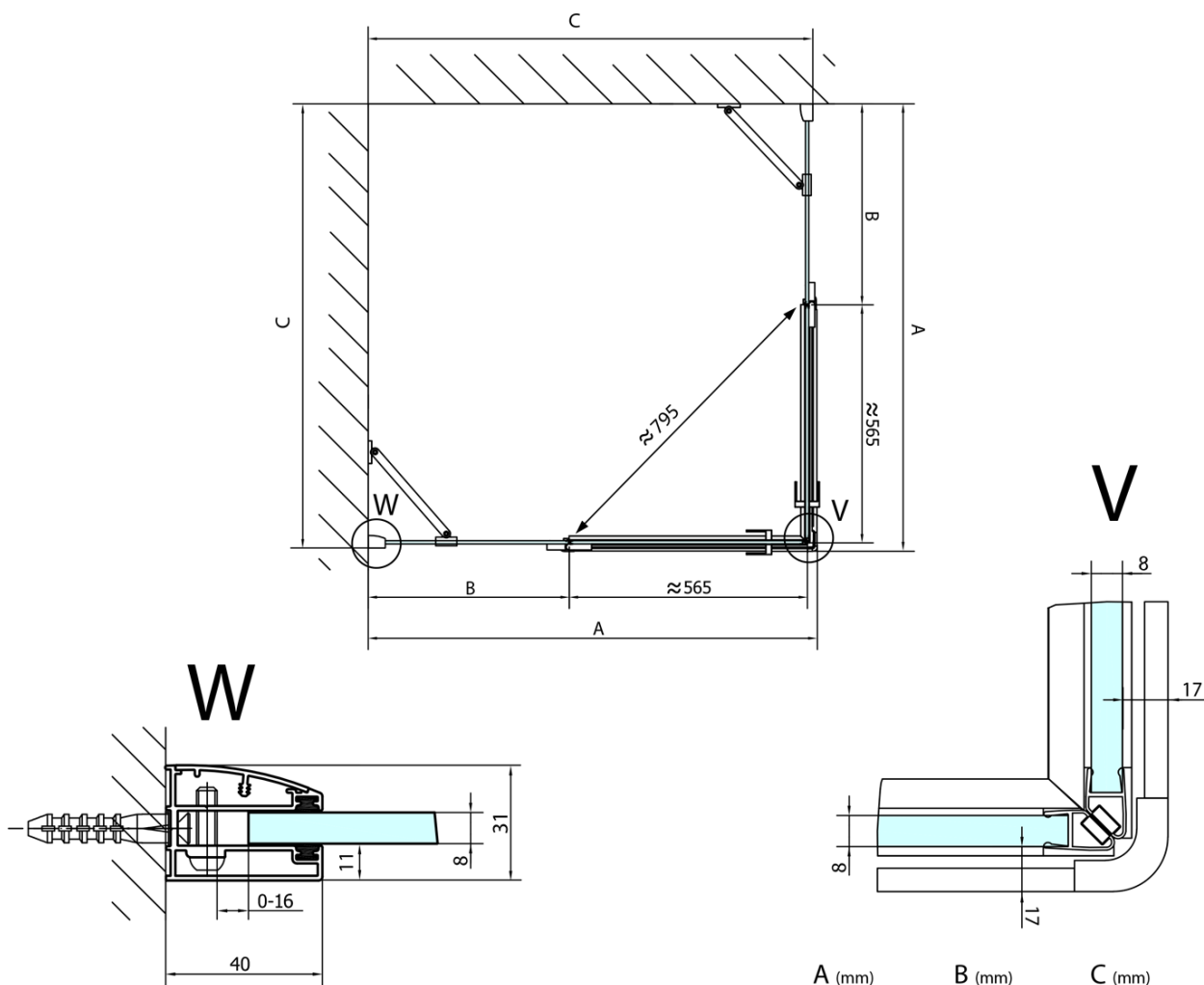

	A (mm)	B (mm)	C (mm)
FL1080	785-801	≈ 210	779-795
FL1090	885-901	≈ 310	879-895
FL1010	985-1001	≈ 410	979-995
FL1011	1085-1101	≈ 510	1079-1095
FL1012	1185-1201	≈ 610	1179-1195
FL1113	1285-1301	≈ 710	1279-1295
FL1114	1385-1401	≈ 810	1379-1395
FL1115	1485-1501	≈ 910	1479-1495



FL10xxL
FL11xxL

FL3580
FL3590
FL3510
FL3511
FL3512

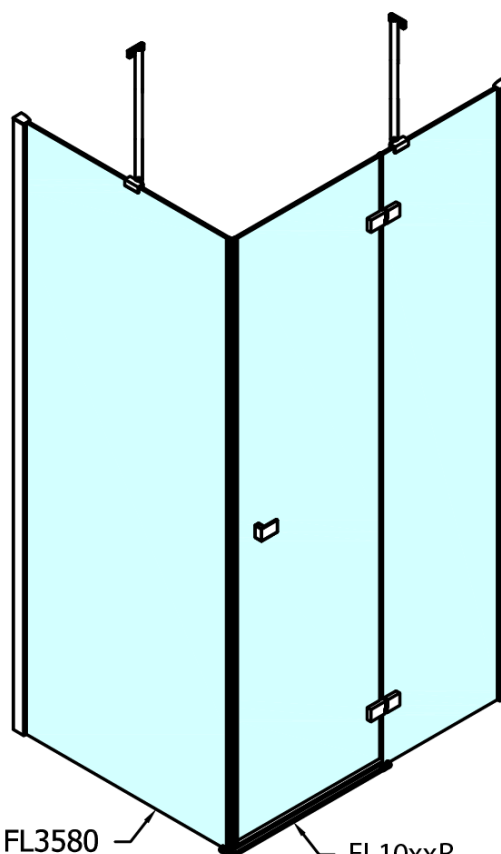

FL3580
FL3590
FL3510
FL3511
FL3512

FL10xxR
FL11xxR



Dveře	A (mm)	B (mm)	C (mm)
FL1080	785-801	≈ 200	779-795
FL1090	885-901	≈ 300	879-895
FL1010	985-1001	≈ 400	979-995
FL1011	1085-1101	≈ 500	1079-1095
FL1012	1185-1201	≈ 600	1179-1195
FL1113	1285-1301	≈ 700	1279-1295
FL1114	1385-1401	≈ 800	1379-1395
FL1115	1485-1501	≈ 900	1479-1495

Boční stěna	E	D
FL3580	785-801	779-795
FL3590	885-901	879-895
FL3510	985-1001	979-995
FL3511	1085-1101	1079-1095
FL3512	1185-1201	1179-1195



Stavební připravenost pro montáž na dlažbu
 kóty x, y = Rozměr k vnitřní straně skla

Construction readiness for floor mounting
 dimensions x, y = Dimension to the inside of the glass



Dveře	X (mm)	B (mm)
FL1080	768	≈ 200
FL1090	868	≈ 300
FL1010	968	≈ 400
FL1011	1068	≈ 500
FL1012	1168	≈ 600
FL1113	1268	≈ 700
FL1114	1368	≈ 800
FL1115	1468	≈ 900

Boční stěna	Y
FL3580	768
FL3590	868
FL3510	968
FL3511	1068
FL3512	1168

