

SOLARIS

— Tap inspiration —

 **SAPHO**

AT SAPHO
WE CELEBRATE
EXCEPTIONAL DESIGN.

WE BRING
INNOVATION.

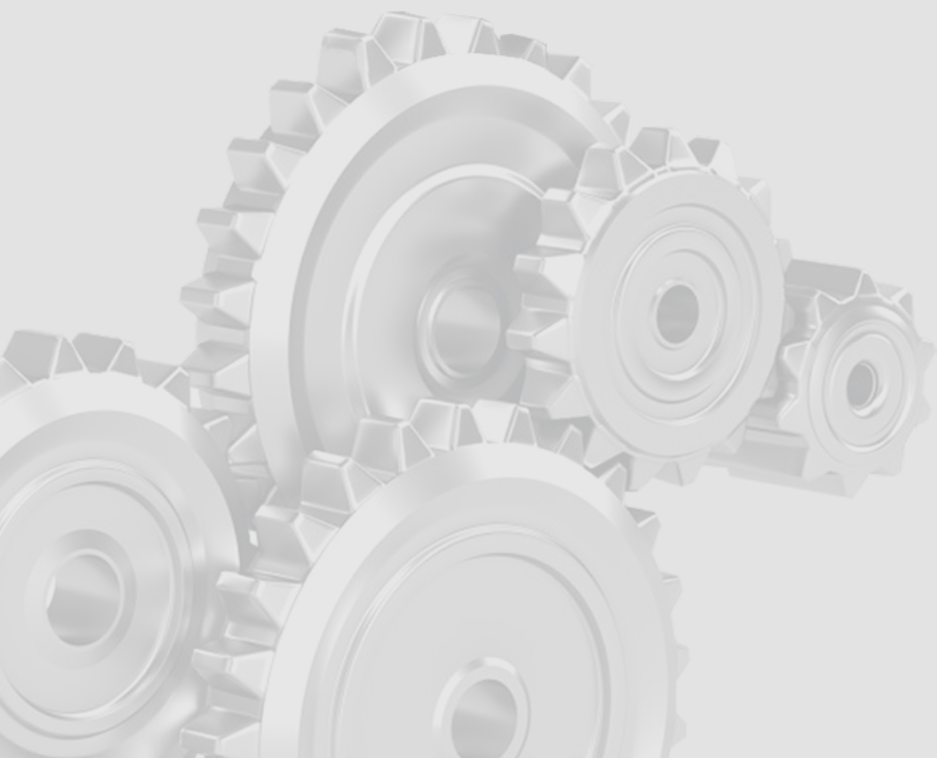





SOLARIS



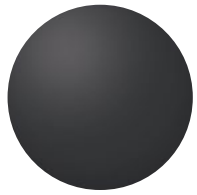

MATT BLACK







SOLARIS

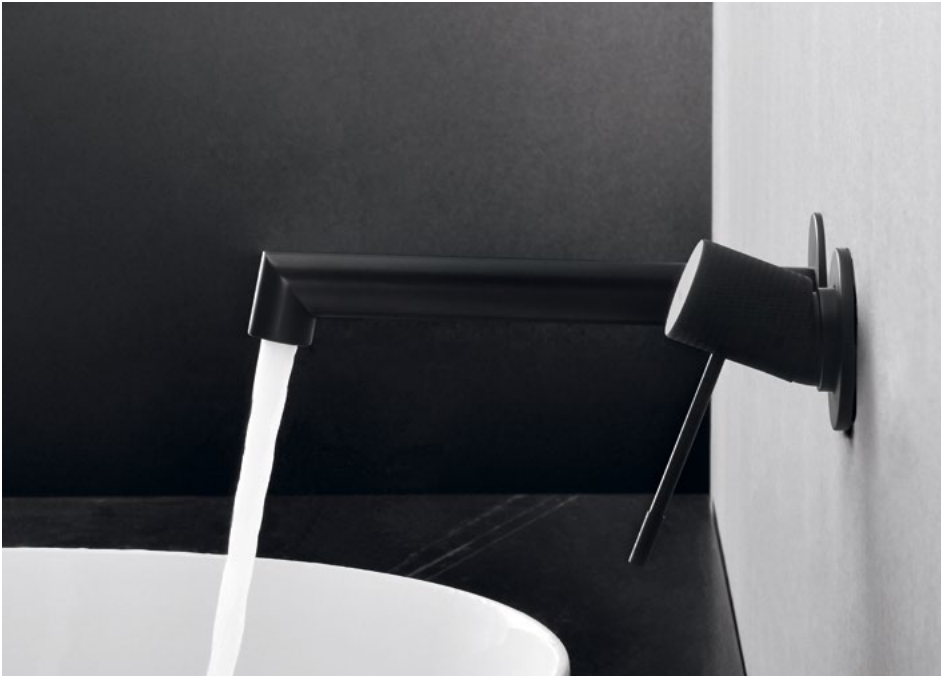

MATT BLACK



● MATT BLACK



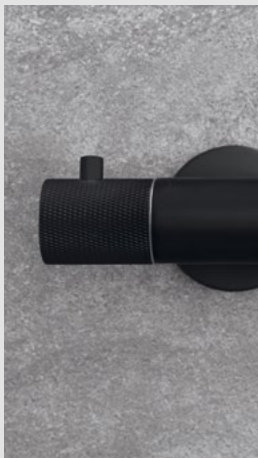



ANTI
CALC

Resistance to limescale build-up.
Easy cleaning of silicone nozzles.



AIR
MIX

Water and air mixing
system for water saving.



HiTech Therm - burn protection.
The tap surface is not heated
by hot water.



Safety button

when the temperature exceeds 38°C



Control

Rotary handle for switching modes



SOLARIS COLLECTION

MATT BLACK

GOLD



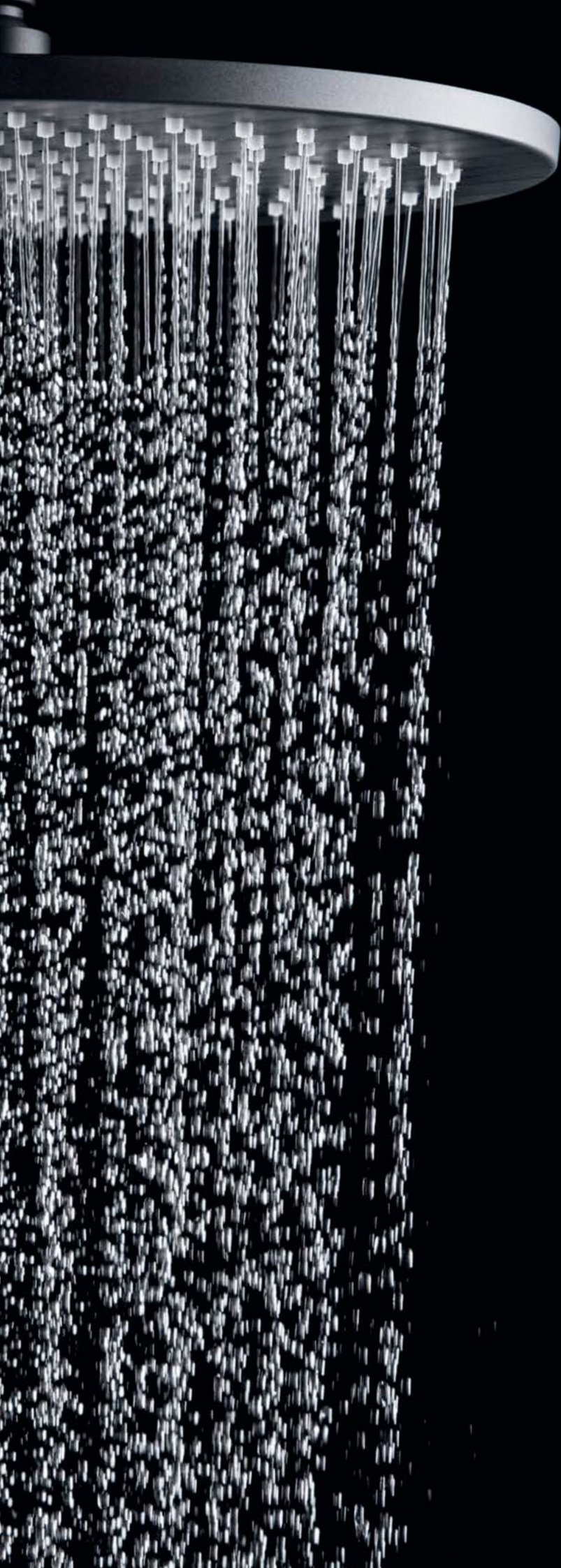



SOLARIS
CHROME
MATT BLACK





528-10





AT VARIOUS HEIGHTS

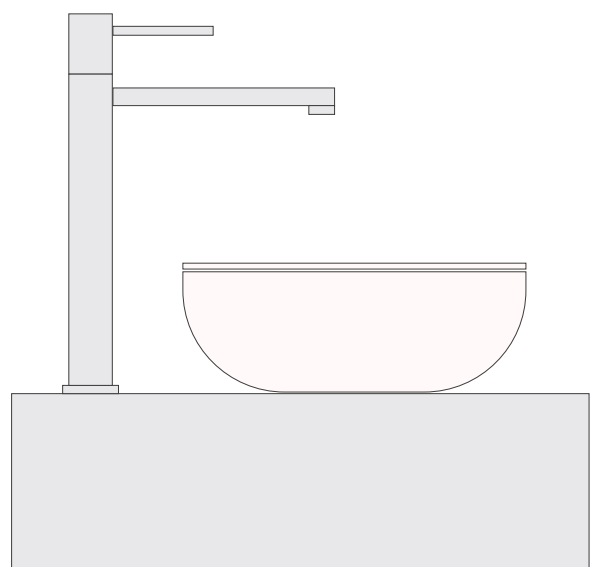
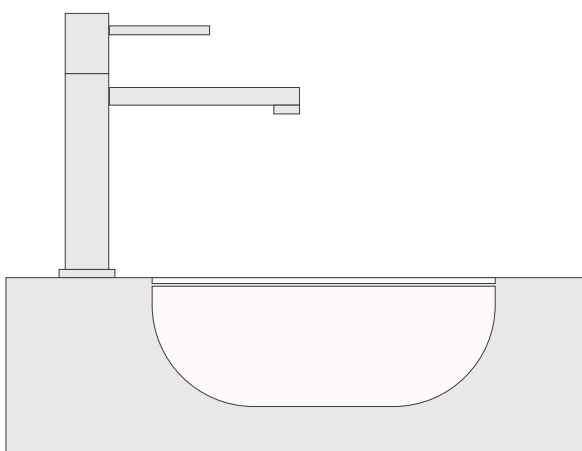

Our taps taps can be combined with all types of washbasins.

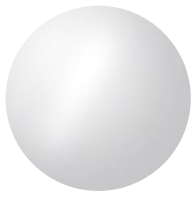

CHROME



● CHROME





EASY SYSTEM

Easy removal of the thermostatic cartridge allows for quick cleaning.

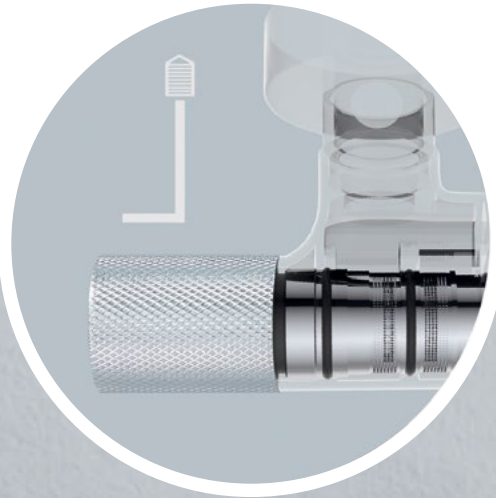

Constant water temperature.
Safety button when temperature exceeds 38 °C.

Advantages of thermostatic mixers



Rotary handle for switching between
shower and bath spout.



WD002G



● Chrome

● Matt Gold (PVD)

● Matt Black

● Matt Copper (PVD)



WD006PG



● Chrome

● Matt Gold (PVD)

● Matt Black

● Matt Copper (PVD)



WD008B

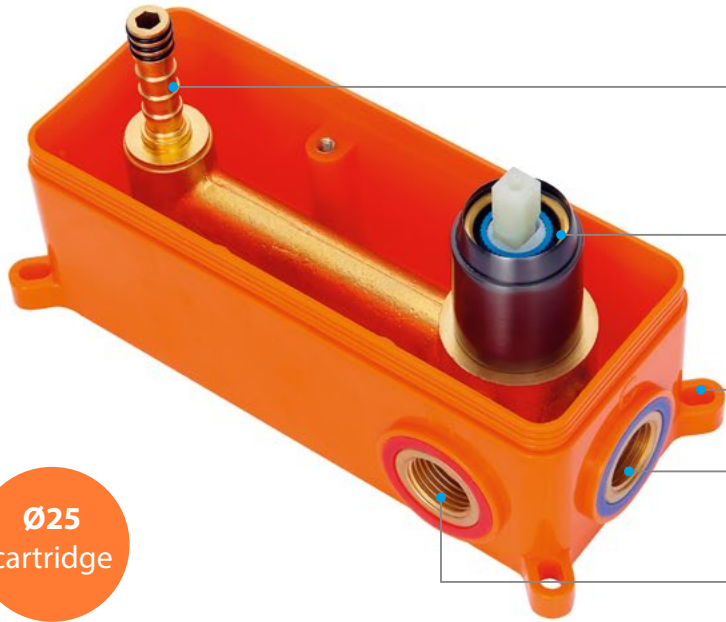

outlet connection

mixing cartridge

fastening points

cold water inlet

hot water inlet

Ø25 cartridge



WD008



WD008CB



WD008G



WD008PG

Chrome

Matt Gold (PVD)

Matt Black

Matt Copper (PVD)



WD010CB



thermostatic
head

Chrome

Matt Gold (PVD)

Matt Black

Matt Copper (PVD)



WD139B



thermostatic head

Chrome

Matt Gold (PVD)

Matt Black

Matt Copper (PVD)

UBC s.r.o.

250 65 Líbeznice, Mělnická 87, tel.: 283 090 760
e-mail: info@sapho.cz, www.sapho.eu

UBC s.r.o. reserves the right to change specifications without prior notice.